

Contents

1 Safety.....	1
2 Overview of DataHub.....	2
2.1 Introduction	2
2.2 Appearance	2
2.3 LED Indicator.....	2
3 Installation	4
3.1 Packing List.....	4
3.2 Device Installation.....	4
3.2.1 Indoor Wall Mounting.....	4
3.2.2 Guide Rail Mounting.....	5
4 Cascade Connection.....	6
4.1 Inverter Connection	6
4.2 Installation of RS485	6
4.3 Installation of DI Signal Cable	7
4.4 Installation of AI Signal Cable.....	7
4.5 Installation of DO Signal Cable.....	8
4.6 Installation of Network Cable.....	8
4.7 Connecting to Ripple Control Receiver.....	9
4.8 Connecting to DRED.....	9
5 Configuration Function.....	10
5.1 Login.....	10
5.2 Site Management	10
5.2.1 Add Device	10
5.2.2 Device Detail	12
5.3 Sits Setting.....	12
5.3.1 Export Limit Control	12
5.3.2 Power Control.....	13
5.3.3 Meter Reversion.....	14
5.4 Inverter Setting	14
5.4.1 Inverter Active/Reactive Power Setting.....	14
5.4.2 Remote System Switch	14
5.4.3 Parameter Setting.....	15
5.5 Inverter Upgrade.....	15
5.6 DataHub Setting.....	15



5.6.1 Internet Setting.....	15
5.6.2 Time Setting.....	15
5.6.3 Serial Port Settings	16
5.6.4 Other Setting.....	16
5.6.5 Datahub Information.....	17
5.6.6 DataHub Upgrade	17
5.7 Password Modification	17
5.8 System Resetting	18
6 Technical Specifications	19
7 Certified Quality Assurance.....	20
7.1 Certification mark.....	20
7.2 Warranty.....	20
7.3 Warranty Conditions	20
7.4 Exclusion of Liability	20
8 Contact Us	21

1 Safety

The DataHub produced by SolaX Power Network Technology (Zhejiang) Co., Ltd. has been designed and tested strictly in accordance with relevant safety regulations. The safety instructions must be followed when installing and maintaining the electrical and electronic equipment. Improper operation will cause personal injury and property damage to the operator and the third party.

- Children should be supervised to ensure that they do not play with DataHub;
- Please do not open the top cover. Touching or replacing the components without authorization of SolaX may cause personal injury or DataHub damage. SolaX does not assume any responsibility and warranty; and
- Static electricity may damage the electronic components; therefore, appropriate anti-static measures should be taken.

2 Overview of DataHub

2.1 Introduction

DataHub, a special equipment of the monitoring platform of photovoltaic power generation system, has realized many functions, with details as follows: interface aggregation, data acquisition, data storage, output control, and centralized monitoring and centralized maintenance of inverters, electricity meters, environmental monitors and other equipment in photovoltaic power generation systems.

2.2 Appearance

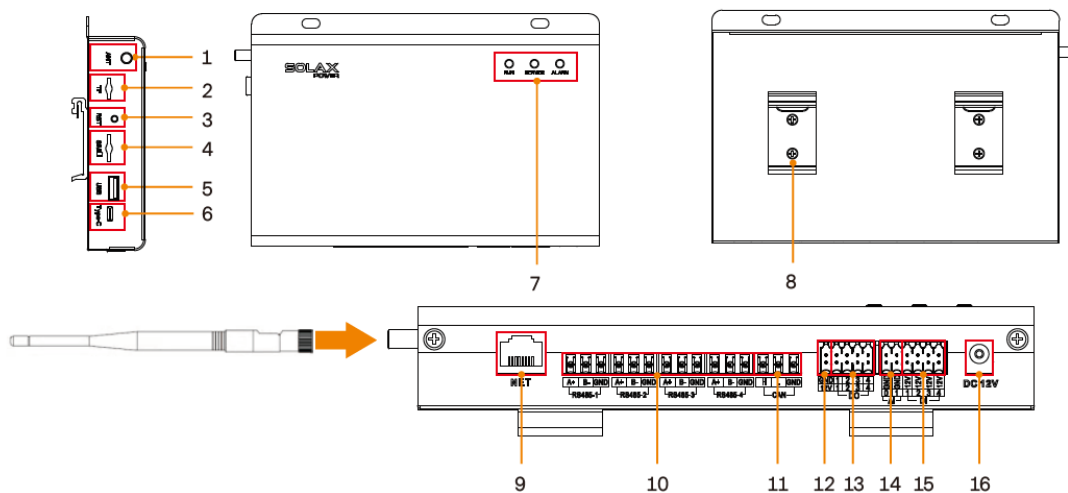

- (1) Antenna jack
- (2) TF card socket (TF)
- (3) RST button (RST)
- (4) SIM card socket (SIM)
- (5) USB socket (USB)
- (6) TYPE-C socket
- (7) LED indicator (RUN,SERVER,ALARM)
- (8) Rail clip
- (9) NET socket (NET)
- (10) RS485 socket (RS485)
- (11) CAN socket (CAN)
- (12) 12V power output (12V/GND)
- (13) DO socket (DO)
- (14) AI socket (AI)
- (15) DI socket (DI)
- (16) 12V power input (DC12V)

2.3 LED Indicator

Sign	Status	Explanation
RUN (GREEN)	Flash	The program runs normally.
	No Flash	The program runs abnormally.
SERVE	ON	The network connection is normal.



Sign	Status	Explanation
(GREEN)	OFF	The network connection isn't normal.
ALARM	ON	Device alarm
(RED)	OFF	No alarm

3 Installation

3.1 Packing List

After receiving the package of DataHub, please check whether the accessories are complete and there is no obvious damage to the appearance. If there is any damage or items missing, please contact the dealer.

Packing List

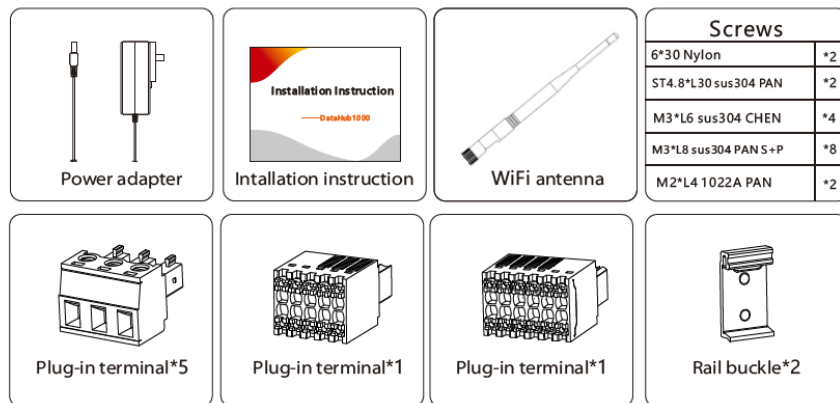

Line Specification	
RS485	Cross-sectional area 0.2mm ² ~2.5mm ² (24AWG ~ 14AWG) dual-core or multi-core cables
DO/DI/AI	Cross-sectional area 0.2mm ² ~1.5mm ² or (24AWG ~ 16AWG) dual-core or multi-core cables
NET Cable	Cat 5e or higher standard network cable

3.2 Device Installation

3.2.1 Indoor Wall Mounting

- 1) Choose a flat and solid indoor wall to drill for installation;
- 2) Hang the DataHub on the wall with the cable connection area facing down.

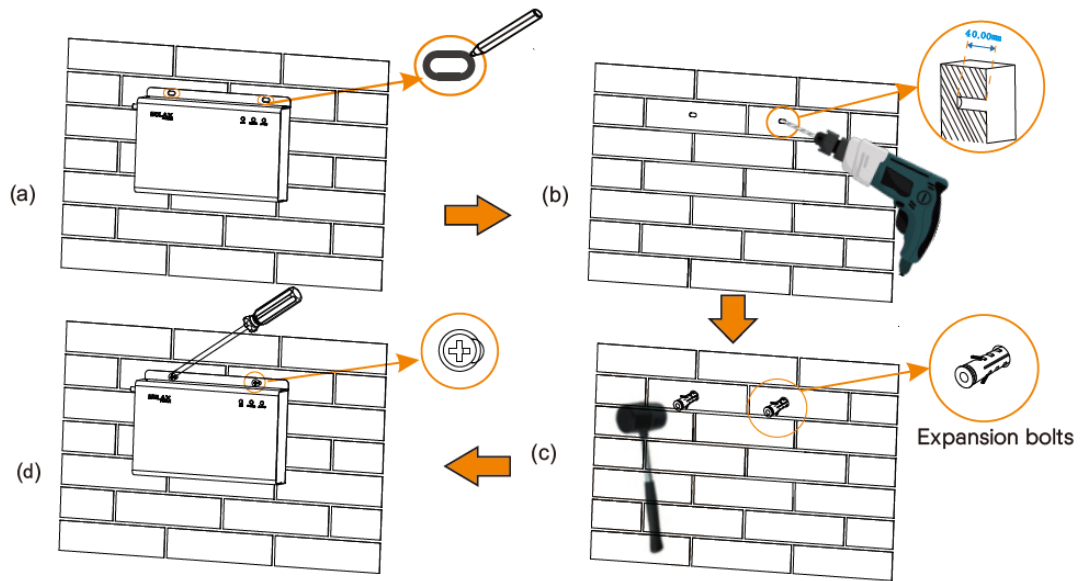

3.2.2 Guide Rail Mounting

- 1) Use the four M3*L6 screws in the accessory bag to fix the buckle on the DataHub.
- 2) Please prepare 35mm standard rail (effective length $\geq 230\text{mm}$) and install it firmly.

**Note: The outdoor installation must be in a waterproof housing.*

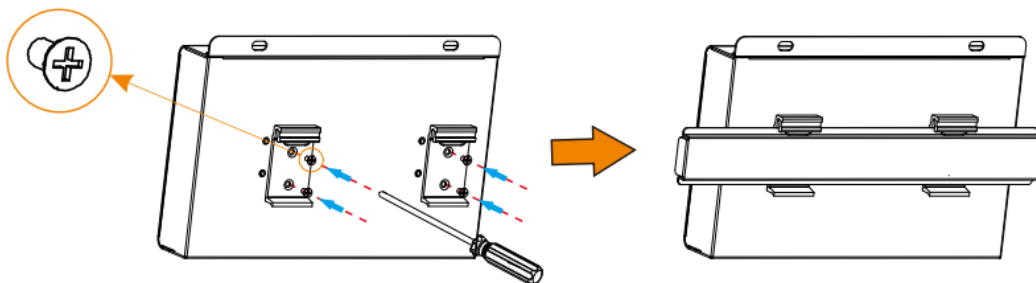

4 Cascade Connection

4.1 Inverter Connection

- 1) The inverter is connected to the DataHub through the RS485 daisy chain. For the connection method of the inverter, please refer to the inverter installation manual;
- 2) It is recommended that the number of devices connected to each channel of RS485 is less than 20;
- 3) The baud rate, communication protocol and verification method of the inverters connected to the same RS485 port of DataHub must be consistent, and the communication addresses of the inverters must be consecutive and not repeated.

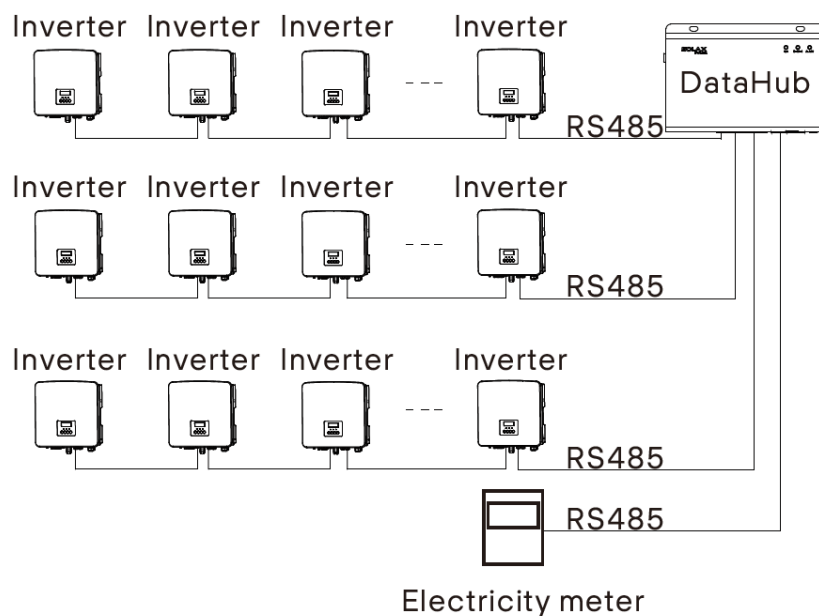

4.2 Installation of RS485

Make sure that RS485+ is connected to DataHub's RS485+, RS485- is connected to DataHub's RS485-, RS485 GND is connected to the GND of DataHub.

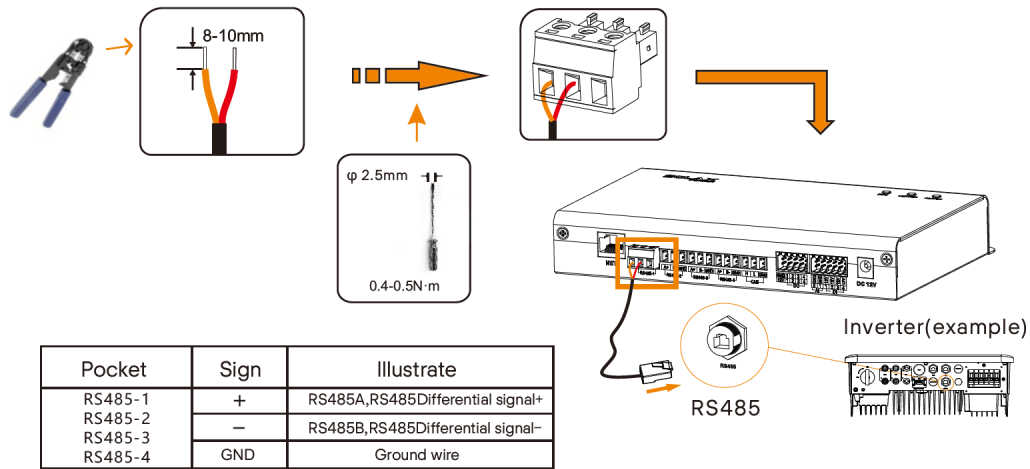

4.3 Installation of DI Signal Cable

DataHub can access DI signals such as remote control and alarms through the DI port.

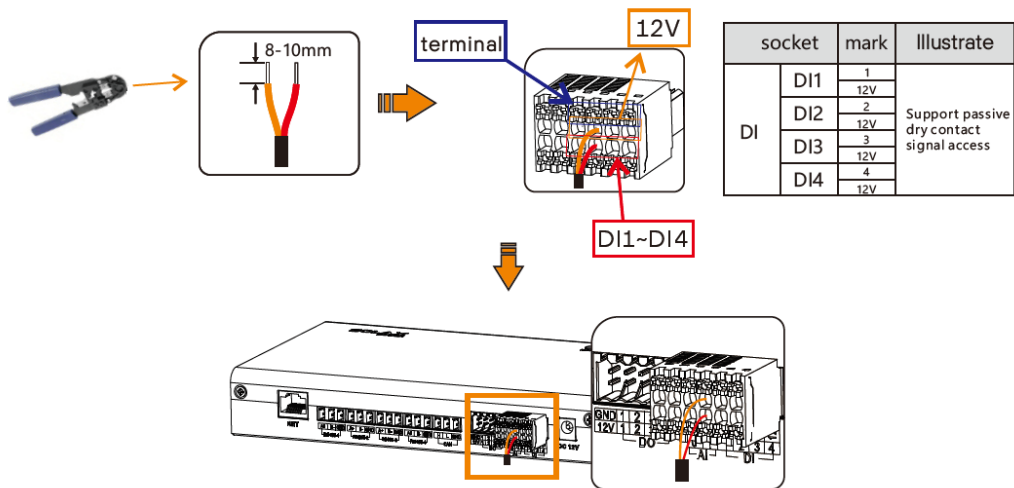

4.4 Installation of AI Signal Cable

Installation advice:

- It is recommended that the transmission distance does not exceed 10 m;
- AI port 0 and AI port 1 are connected to AI signal +, and GND is connected to AI signal-.

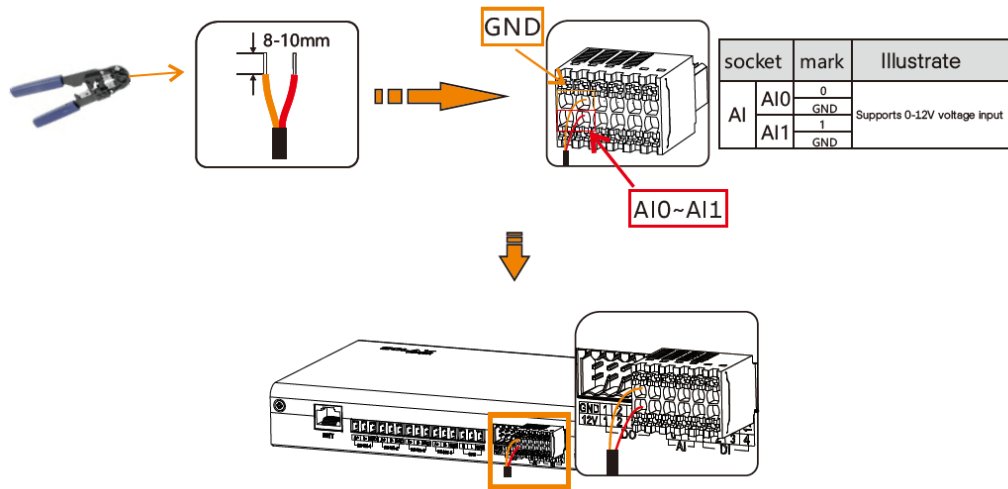

4.5 Installation of DO Signal Cable

The DO port supports 12V signal voltage in maximum. The contact of four-group output is on by default.

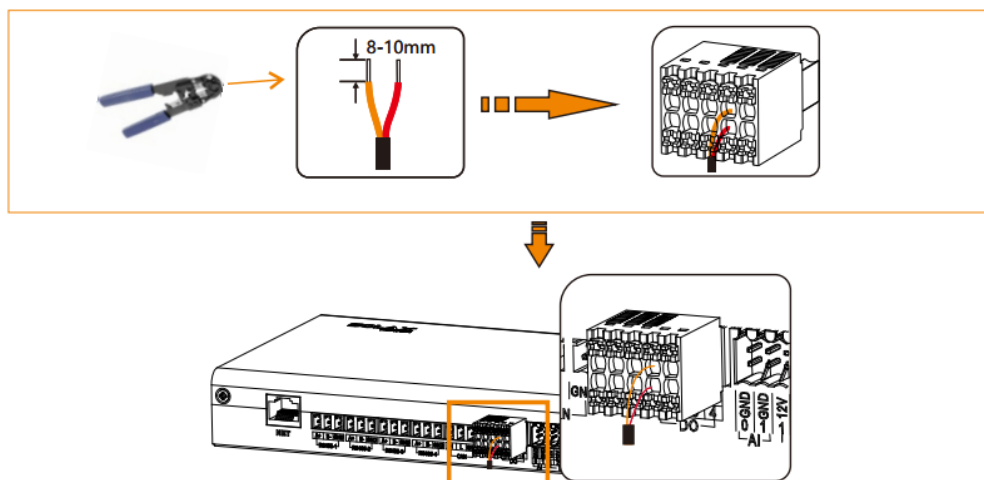

4.6 Installation of Network Cable

- Use Cat 5e or higher specifications and Shielded crystal head connectors to prepare the network cable.
- The communication distance does not exceed 100 m.
- When crimping the network cable, ensure that the shielding layer of the network cable is properly connected to the metal shell of the RJ45 connector.

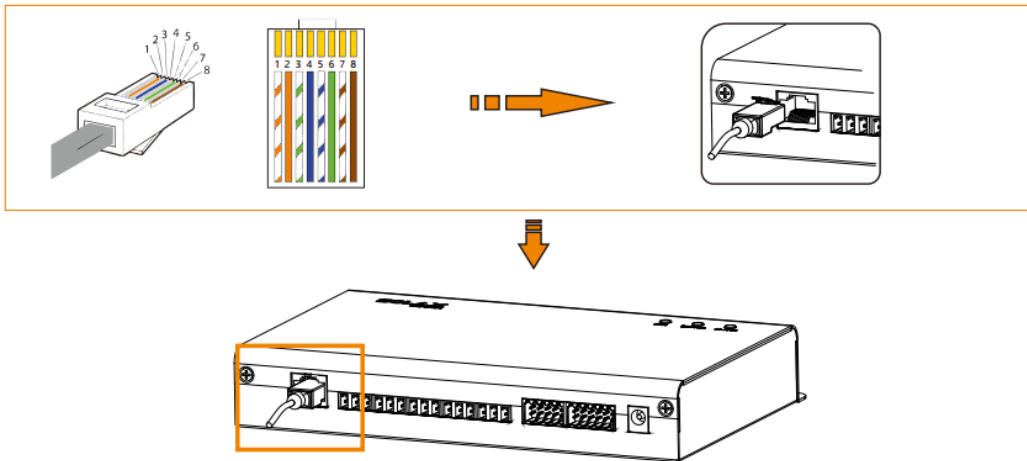

4.7 Connecting to Ripple Control Receiver

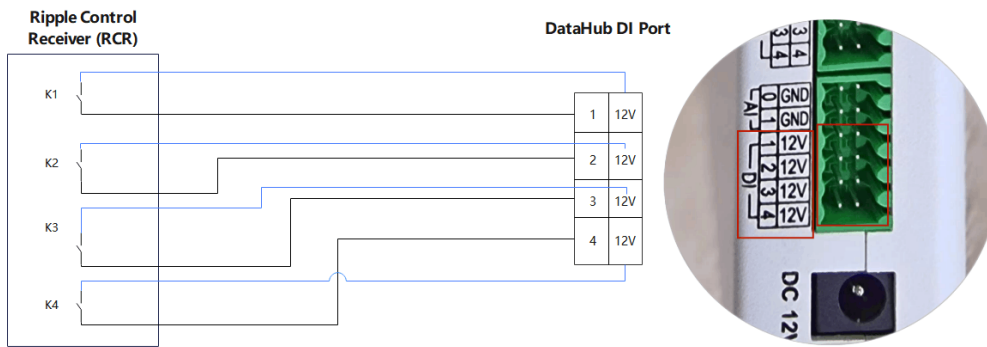

4.8 Connecting to DRED

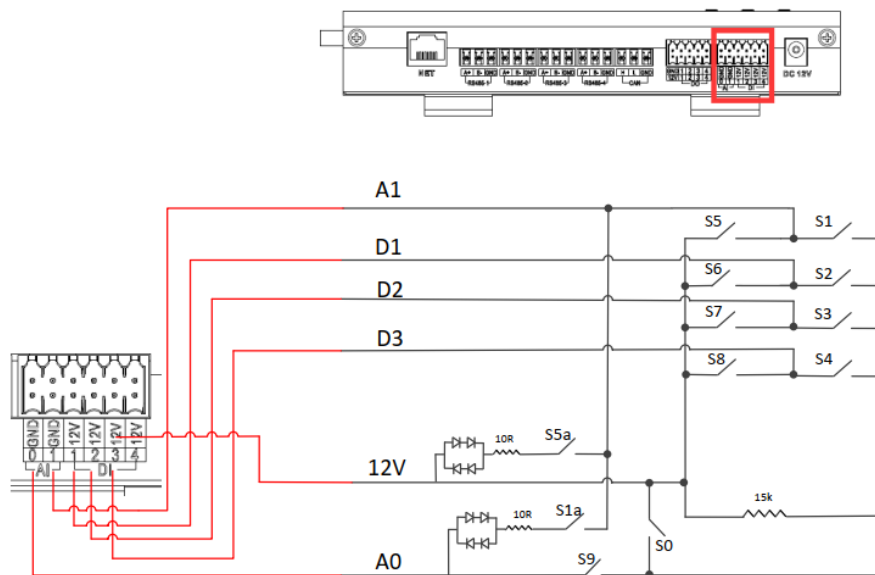

5 Configuration Function

5.1 Login

Hotspot login: connect the computer to the DataHub hotspot (WiFi _xxxxxxx), and use the computer to access 5.8.8.8 to enter the login interface .

WiFi login: Connect the computer and DataHub to the same WiFi, and then visit <http://datahub.local/> to log in. If the user cannot access, please install the Bonjour SDK, or log in through the DataHub LAN IP address.

After entering the login interface, enter the account name and the corresponding initial password:

Administrator account: admin, initial Password: (the same as Registration Number).

User account: user, initial Password: 123456. Visitor account: visitor, initial Password: 123456.

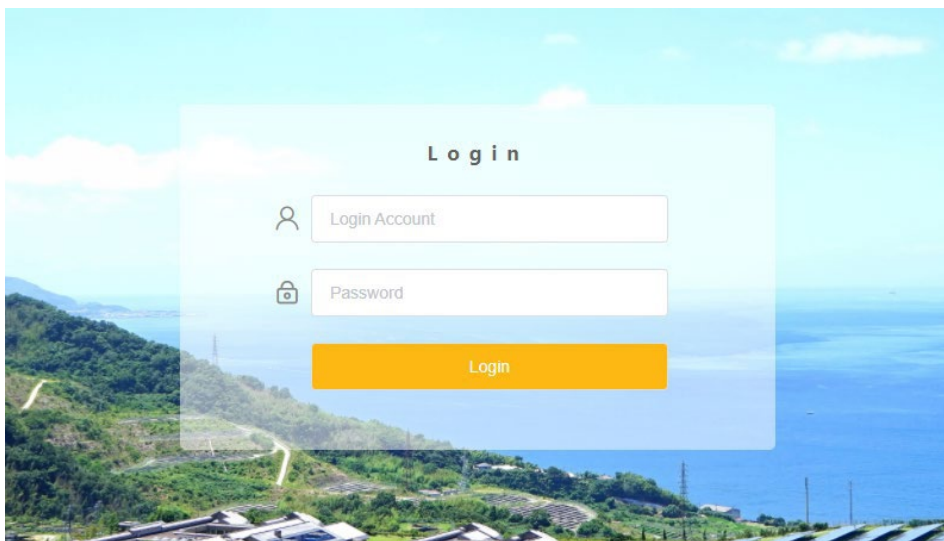

5.2 Site Management

5.2.1 Add Device

The devices supported by DataHub are as follows: Inverters, Electricity Meters, and Environmental Monitors.

Select the device type under the serial port, set the starting address and the number of devices under the serial port, and save these settings.

RS485 Channel	Device Type	Initial Address	Number of Devices
1	Inverter	1	1
2	Inverter	0	0
3	Inverter	0	0
4	Meter	0	0

Check Device Detail Save

The device details will pop up. Please confirm whether the model is correct and then Click “Save”.

Device Detail ×

RS485 Channel	Device ID	SN	Device Type	Device Type
1	1	unknown	Inverter	unknown

Update Device Type Save

5.2.2 Device Detail

Click the corresponding device to query the device data, or select the device to export the device data.

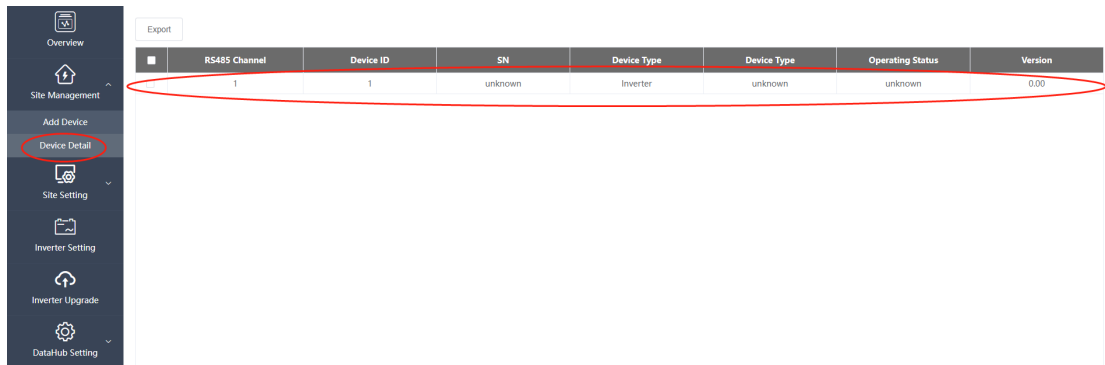

RS485 Channel	Device ID	SN	Device Type	Device Type	Operating Status	Version
1	1	unknown	Inverter	unknown	unknown	0.00

5.3 Sits Setting

“Site setting” is equipped with three modules, which are “export limit control”, “power control” and “meter reversion”. The “export limit control” and the “power control” are mutually exclusive so that only one can be enabled.

5.3.1 Export Limit Control

The purpose of the “export limit control” is to limit the power supplied to the grid. The inverter generates electricity to the grid when the power source is positive, and takes electricity away from the grid when the power source is negative. For example: The exported power is set to 0kW, the power generated by inverter is 5kW, the power load consumed is 4kW, the inverter generates 1kW(5kW-4kW = 1kW), then DataHub will limit the power generated by inverter to 4kW.

The control methods are divided into “average phase control” and “minimum phase control”. If the “export power” were limited to 0kW, there will be no influence on a single-phase inverter, the inverter will not supply power to the grid. As for a three-phase inverter, the “average phase control” is to average the power of the three phases generated by the inverter. For example: the three-phase loads are 3kW, 4kW and 5kW respectively, a total of 12kW. Under the “average phase control”, the power generated by the three-phase inverter is 4kW, 4kW, and 4kW respectively, a total of 12kW, as well.

Under the “minimum phase control”, the power generated by the three-phase inverter is 3kW, which is the minimum power of the three-phase loads.

**Note: Before using the “export limit control” function, make sure that a meter has been added to the DataHub. The output of device will be abnormal when connecting to three phase three wire under “minimum phase control” mode.*

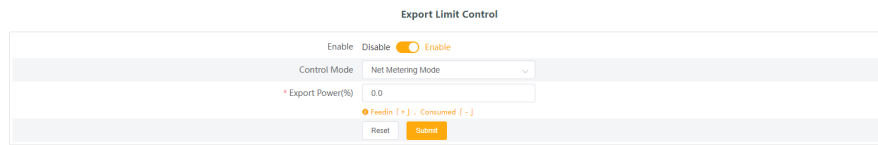
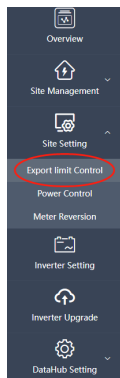

5.3.2 Power Control

Power control includes “ripple control” and “DRM control” disable.

The “ripple control” is to control the active power and reactive power of the inverter according to the high or low input of the DI port. There are a total of 16 situations for users to set the active and reactive power according to each situation.

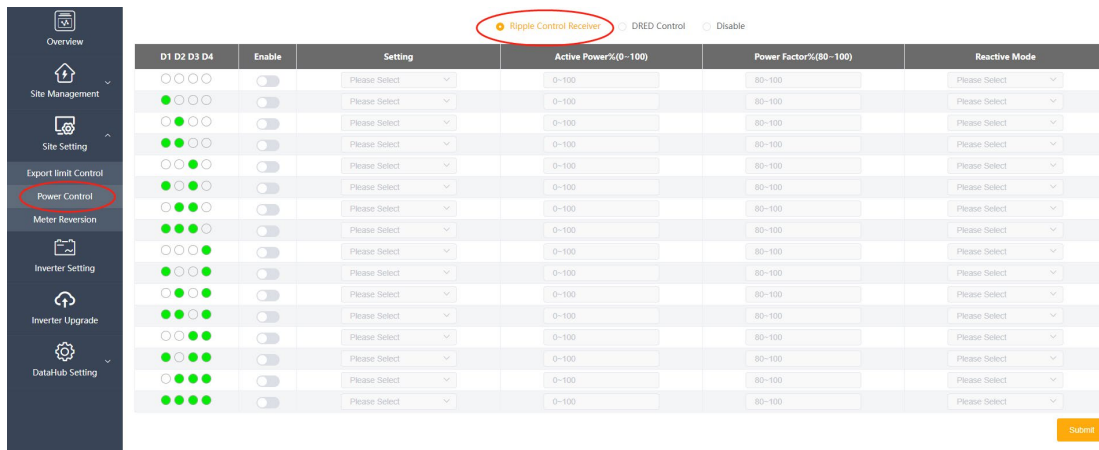

DRED control is applied to set the active power according to high or low input of the A1, D1, D2, D3 and D4 of DI ports.

Mode	Operate	Explanation	Note
DRM0	Close S9,S0	Inverter shutdown	When two or more DRM modes work at the same time, take the optimal result that can satisfy both of them.
DRM1	Close S9,S1, disconnect S0	Close S1, charging power is 0%	
DRM5	Close S9,S5	Inverter does not output active power	
DRM6	Close S9,S6	The active power output by the inverter does not exceed 50% of the rated power	
DRM7	Close S9,S7	The active power output by the inverter does not exceed 75% of the rated power	
DRM8	Close S9,S8	The active power of the inverter output power starts to recover. Description: The inverter outputs according to the active power percentage set by DataHub.	

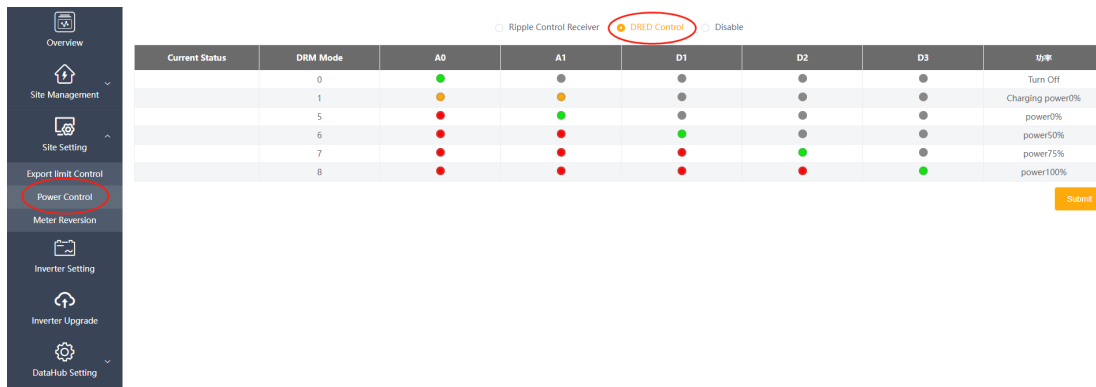

5.3.3 Meter Reversion

When the current direction of the users meter is reversed, there is no need to rewire, just turn on the enable switch and submit this setting.

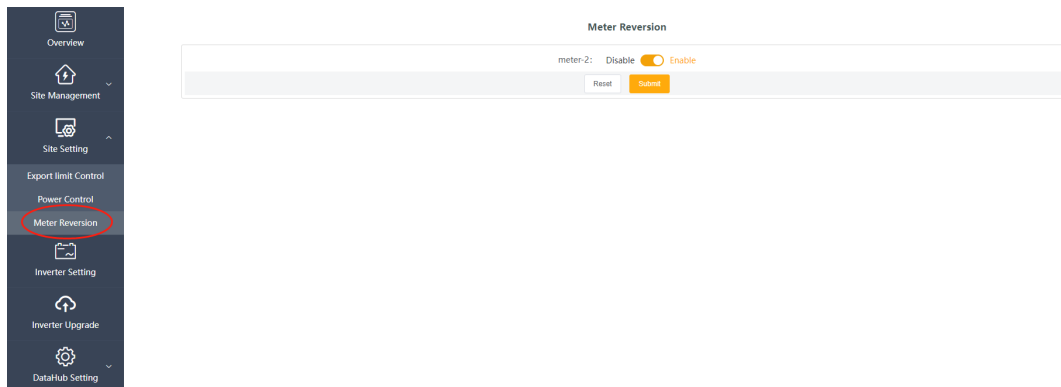

5.4 Inverter Setting

There are three functions under "inverter setting": "inverter active/reactive power setting", "remote system switch" and "parameter setting".

5.4.1 Inverter Active/Reactive Power Setting

Remotely set the active or reactive power of the inverter. The reactive power mode is divided into "overexcited", "underexcited", "fixed reactive power" and "disable" terms. (multiple selections are available)

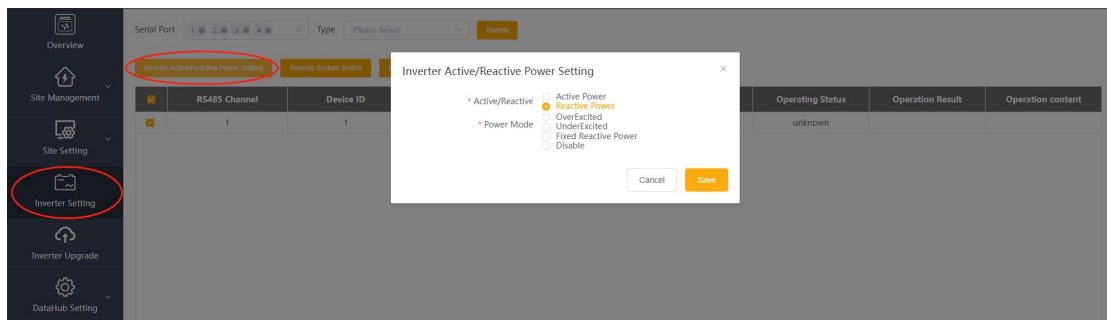

5.4.2 Remote System Switch

Select the inverter to be controlled (Inverters can be selected in batches)

5.4.3 Parameter Setting

Professionals can read and write the inverter through the inverters “modbus opcode”, under which there are “READ_HOLDING_REGISTERS”, “READ_INPUT_REGISTERS”, “WRITE_SINGLE_REGISTER” and “WRITE_MULTIPLE_REGISTERS”. (Can be operated in batches)

5.5 Inverter Upgrade

Using DataHub to upgrade the inverter. Click “Upgrade” to select the upgrade file types which include “ARM”, “MDSP”, “SDSP”, “ARC”, “ARM+DSP”, “BMS_M” and “BMS_S”. Select the corresponding file to upgrade the inverter.

**Note: It takes nearly 15-30 minutes to upgrade the inverter. During upgrading, no data will be uploaded.*

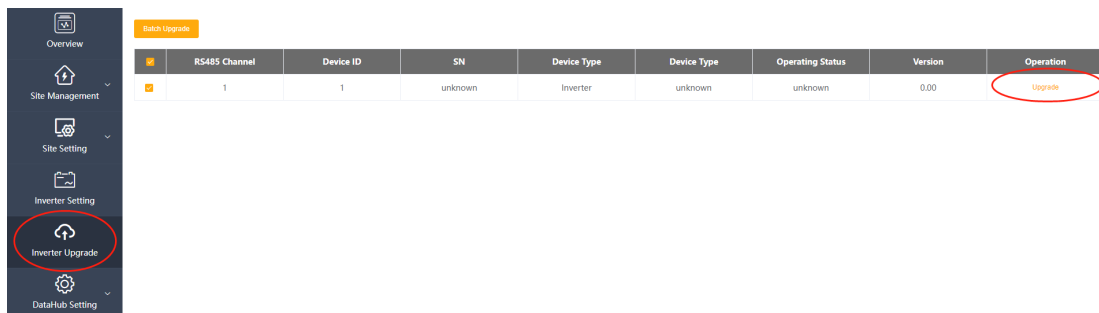

5.6 DataHub Setting

5.6.1 Internet Setting

Network settings are divided into: “IP setting” and “WiFi setting”.

IP setting: If the user needs to fix the IP, select the correct network card type, turn off the automatic acquisition of IP address, and set the “IP address”, “subnet mask”, “gateway” and “DNS”.

WiFi setting: Provides the function of connecting to WiFi.

**Note: Ordinary users do not need to perform any operations if they do not need a fixed IP.*

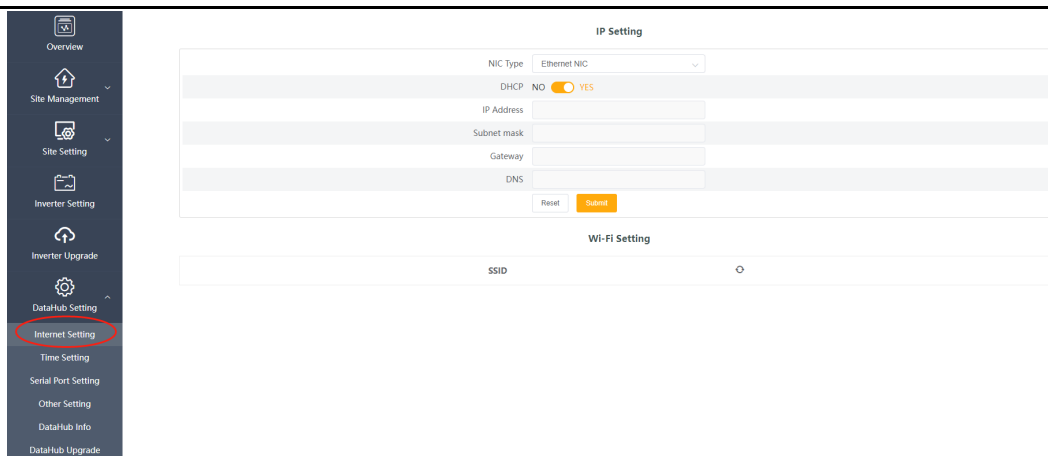

5.6.2 Time Setting

The time setting is to set the DataHub system time, including “time synchronization”, ”SolaXCloud synchronization” and “other server synchronization”.

“Time synchronization”: The system corrects the time automatically.

“SolaXCloud synchronization”: The platform of SolaX sends a synchronization command to change the time of system.

“Other server synchronization”: The IEC104 server sends a synchronization command to change the time of system.

5.6.3 Serial Port Settings

Serial port settings is to set the baud rate of the four serial ports of DataHub, the default value of the baud rate is 19200. The user can change the baud rate under the serial port according to the model.

**Note: The baud rate of the model under the serial port is consistent, and it is consistent with the serial port baud rate set by datahub. The default value of the stop bit is 1.*

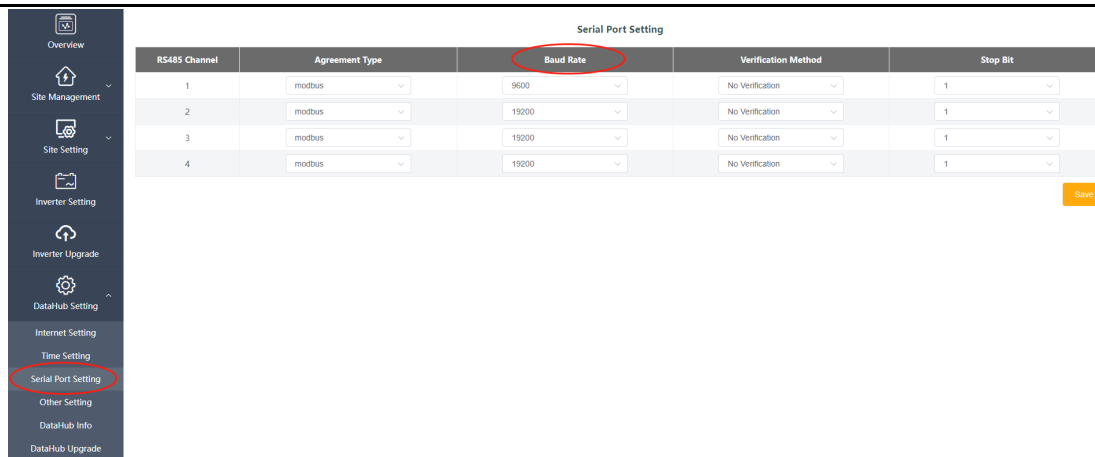

RS485 Channel	Agreement Type	Baud Rate	Verification Method	Stop Bit
1	modbus	9600	No Verification	1
2	modbus	19200	No Verification	1
3	modbus	19200	No Verification	1
4	modbus	19200	No Verification	1

5.6.4 Other Setting

The “platform setting” is the setting to upload the data to the platform, the data is sent to SolaXCloud by default, and the other is sent to the IEC104 server.

The “database storage setting” is a path for inverters to store data. There are two storage paths including the “default” and the “SD card”. The “default” is to store data on the Datahub.

Electricity price setting: Calculate the income through the electricity price and display it in the overview interface.

“CO₂ savings factor”: Calculate the amount of CO₂ through the coefficient and display it in the overview interface.

**Note :*

It is recommended to use a TF card with a capacity of 16G;

If the database storage path is a TF card, the TF card cannot be pulled out when the system is running. If you want to pull out the TF card, you need to change the storage path to the default, and then pull out the TF card. (It is recommended to unplug after power off)

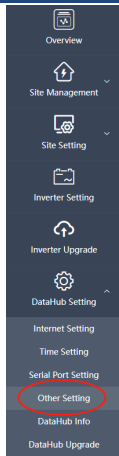

Cloud Platform Setting

Data Upload Platform	SolaXCloud
Local Address	
Platform Server Address	
Platform Server Port	
<input type="button" value="Reset"/> <input type="button" value="Submit"/>	

Database Storage Settings

Database Storage Path	Default
<input type="button" value="Reset"/> <input type="button" value="Submit"/>	

Electricity Price Setting

Electricity Price Setting(Per kWh)	0.00
<input type="button" value="Reset"/> <input type="button" value="Submit"/>	

CO₂ Savings Factor

CO ₂ Savings Factor	0.997
<input type="button" value="Reset"/> <input type="button" value="Submit"/>	

5.6.5 Datahub Information

“Datahub information” displays the basic information of datahub, including “registration number”, “firmware version”, “internal codes”, “system time”, “memory usage”, “free disk time”, “free SD space”, “Wi-Fi connection”, “lan IP address”, and “WiFi IP address”.

Clear historical data: Clear the historical data of the device.

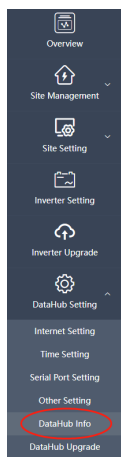

DataHub Info

SN	
Firmware Version	3.09
Internal Codes	V002.02
System Time	2022-04-27 19:21:40
Memory Usage	20.0%
Free Disk Space	4.9G
Free TF Space	NA
Wi-Fi Connection	unknown
LAN IP Address	10.1.1.57
WiFi IP Address	wlan0: error fetching interface information: Device not found

Clearing Historical Data

5.6.6 DataHub Upgrade

Click the “click to upload and upgrade” button to upload and upgrade the DataHub, then select the upgrade file and wait for the upgrading. (Only one file can be uploaded at a time, and the interface needs to be refreshed for continuous operation.)

5.7 Password Modification

The system provides two methods for modification: “modify Password” and “reset user Password”.

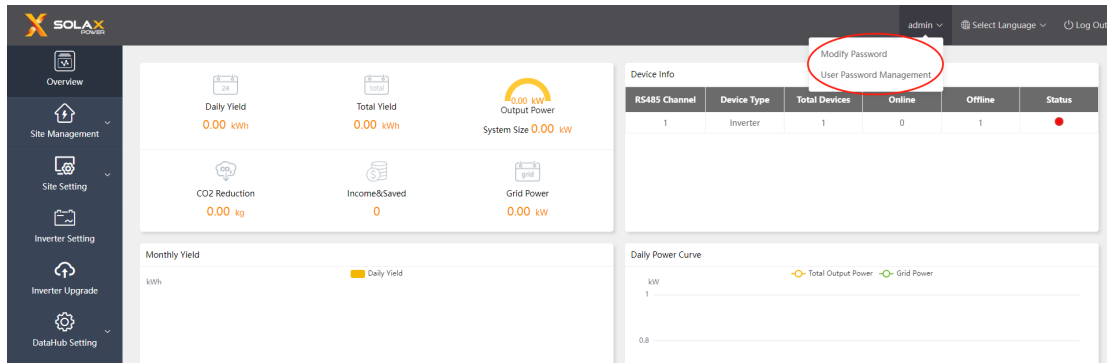

5.8 System Resetting

System resetting restores the system to factory settings, the historical data and the configuration information of datahub will be cleared.

Operation: press and hold the “recover” button for 10 seconds until all three LEDs are off, and then release it. After completing the above operations, the service restarts and the system reset is complete.

6 Technical Specifications

Product	DataHub1000
hardware	
Power adapter	100-240V 50/60HZ AC Input 12V 2A DC Input
Rated power	24W
Data transfer interval	5min
Storage capacity	8G/16G TFcard
The number of managed devices	60
communication	
Inverter communication	3xRS485
wireless module	WiFi 2.4GHz
access network	WiFi
Communication of electricity meters and environmental detectors	1xRS485
Communication distance	wireless >15m, WiFi > 500m
DRM interface	Australia only
USB interface	1 USB Interface (For local upgrade and parameter setting)
Dry Node Control Receiver	2AI,4DI,4DO (Reserved for external expansion)
General parameters	
Dimensions (length*width*height)	205*124*33
Weight	<=500 g
Operating Temperature Range	-20°C ~ +60°C
Degree of Protection	IP21
Installation method	Wall-mounted, rail-mounted
Indicator light	LED
standard	
Certification	RED/FCC/CE/RoHS

7 Certified Quality Assurance

7.1 Certification mark



7.2 Warranty

SolaX grants a standard 24-month warranty, if it is otherwise stipulated in the contract, the contract shall prevail.

7.3 Warranty Conditions

In case the product is operated according to the above instruction, SolaX will provide after-sales service during the product warranty period if any failure (error) is caused by product quality.

7.4 Exclusion of Liability

Warranty claims are excluded for direct or indirect damage due to:

- 1) Warranty period for the product or accessories have expired, but not extended;
- 2) Failure to operate the product in accordance with the installation and maintenance requirements described in the relevant manual;
- 3) Failure or damage caused by not operating, storing and using in the specified working environment;
- 4) Failures or damages caused by unforeseen unexpected factors, human factors or force majeure; and
- 5) Other failures or damages not caused by DataHubs own quality problems.

8 Contact Us

If you have any question or any technical question about DataHub, please contact us through the following methods, we will serve you wholeheartedly.

SolaX Power Network Technology (Zhejiang) Co., Ltd.

ADD: No.288 shizhu Road, Tonglu Economic Zone, Tonglu City, Zhejiang Province, China.

Tel: +86 571 56260011

FAX: +86 571 56075753

EMAIL: service@solaxpower.com

WEB: www.solaxpower.com