



PYLONTECH

P-Combiner-HV-3/6

Instruction Manual

Information Version: 5PMPA08-00154

This manual introduces P-Combiner-HV-3/6 from Pylontech. P-Combiner-HV is the power combination box for Force-H-V2 series battery system. “-3” is for the model having 3 input terminals and 1 output terminal at 50A current. “-6” is for the type having 6 input terminals and 1 output terminal at 100A current. Please follow the instruction carefully during the installation process. Any confusion, please contact Pylontech for advice and clarification.

1. Safety	1
1.1 Symbol.....	1
1.2 EU Declaration of Conformity	3
1.3 Safety Precautions	3
1.4 In Using	3
2. Specification	4
2.1 Equipment interface instruction	5
2.2 Electrical Diagram.....	6
3. Safe handling of lithium batteries guide	7
3.1 Tools.....	7
3.2 Safety Gear.....	7
4. Installation and Operation	8
4.1 Package List	8
4.2 Installation	8
4 Remarks	11

1. Safety

Read all safety instructions carefully prior to any work and observe them when working on the battery.





Incorrect operation may cause:

- Injury or death to the operator or a third party
- Damage to the system hardware and other properties belonging to the operator or a third party.

Skills of Qualified Personnel:

- Training in the installation and commissioning of the electrical system, as well as the dealing with hazards.
- Knowledge of this manual and other related documents.
- Knowledge of the local regulations and directives.

1.1 Symbol

	Danger!
	Caution! Reminding. Safety related information. Risk of battery system failure or life cycle reduces.
	Do not reverse connection the positive and negative.
	Do not place at the children and pet touchable area.
	Warning electric shock.

	<p>Warning Fire.</p> <p>Do not place near flammable material</p>
	<p>Read the product and operation manual before operating the battery system!</p>
	<p>Grounding.</p>
	<p>Recycle label.</p>
	<p>The certificate label for CE</p>
	<p>Label for Waste Electrical and Electronic Equipment (WEEE) Directive (2012/19/EU)</p>
	<p>Label for RoHS direction(2011/65/EU (L 174/88, June 8,2011) and 2015/863/EU)</p>
	<p>Label for IEC 61439-2 from TUV SUD</p>
	<p>Label for UL1741 from CSA</p>

1.2 EU Declaration of Conformity

within the scope of the EU directives

- Restriction of the use of certain hazardous substances 2011/65/EU (L 174/88, June 8,2011) and 2015/863/EU (L 137/10, March 31,2015) (RoHS)
- Waste electrical and electronic equipment 2012/19/EU (L 197/38, 24.7.2012) (WEEE)
- Low-voltage switchgear and controgear assemblies - Part 2: Power switchgear and controlgear assemblies (IEC61439-2)

Pylon Technologies Co., Ltd. confirms herewith that the products described in this document are in compliance with the fundamental requirements and other relevant provisions of the above mentioned directives. The entire EU Declaration of Conformity can be found at en.pylontech.com.cn.

1.3 Safety Precautions



Reminding

- 1) It is important and necessary to read the user manual carefully before installing or using. Failure to do so or to follow any of the instructions or warnings in this document can result in electrical shock, serious injury, or death, or can damage battery, potentially rendering it inoperable, which is out of product warranty scope.
- 2) Do not connect power terminal reversely.
- 3) Please contact the supplier within 24 hours if there is something abnormal.
- 4) Do not expose to flammable or harsh chemicals or vapors.
- 5) Do not connect with PV solar wiring directly.
- 6) Do not connect with AC power.
- 7) Any foreign object is prohibited to insert into any part of box.
- 8) The warranty claims are excluded for direct or indirect damage due to items above.

1.4 In Using

- 1) If any operation required or fuse need replacement, all the power source such as battery, inverter must be turned off and all the cable shall be completely disconnected.
- 2) It is prohibited to connect different battery in parallel through the P-Combiner box.

- 3) It is prohibited to connect inverter with voltage range higher than 600V.
- 4) In case of fire, dry powder fire extinguisher or CO2 fire extinguisher is allowed. Before cutting all power off, water is forbidden to use.
- 5) Please do not open, repair or disassemble the battery except staffs from Pylontech or authorized by Pylontech. We do not undertake any consequences or related responsibility which because of violation of safety operation or violating of design, production and equipment safety standards.

2. Specification

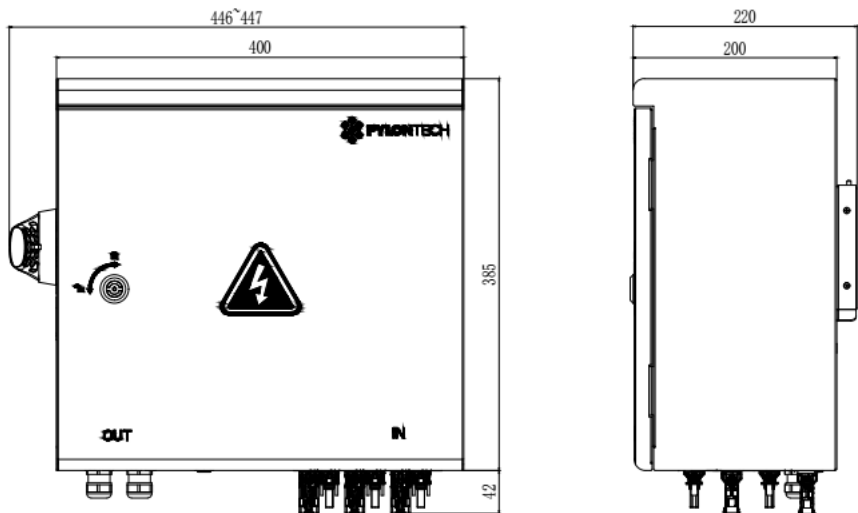

Basic Parameters	P-Combiner-HV-3	P-Combiner-HV-6
Nominal Voltage (V)	600V DC	
Input string	3	6
Input terminal type (+)	H4SMM8DM(AmphenoI)	
Input terminal type (-)	H4SFM8DM(AmphenoI)	
Nominal input current per terminal	50A	
Output string	1	1
Output terminal type	Cable connection(O-ring) M24*1.5	

Basic Parameters	P-Combiner-HV-3	P-Combiner-HV-6
Maximum output current	50A	100A
Ict current of fuse	10kA/100ms	15kA/100ms
Fuse protection breaking capacity	50kA@750V DC	
Disconnecting switch capacity	12kA@1500V DC	
Weight	11.5kg	11.7kg
Dimension	400*385*200	
Working temperature range	-20℃~55℃	
IP rating/type of enclosure	IP55/NEMA 3S	
Humidity	5% ~ 95%(RH) No Condensation	
Altitude(m)	≤4000	
Design life	15+ Years (25℃/77°F)	
Reference standard	IEC61439-1, IEC61439-2, UL1741	

2.1 Equipment interface instruction

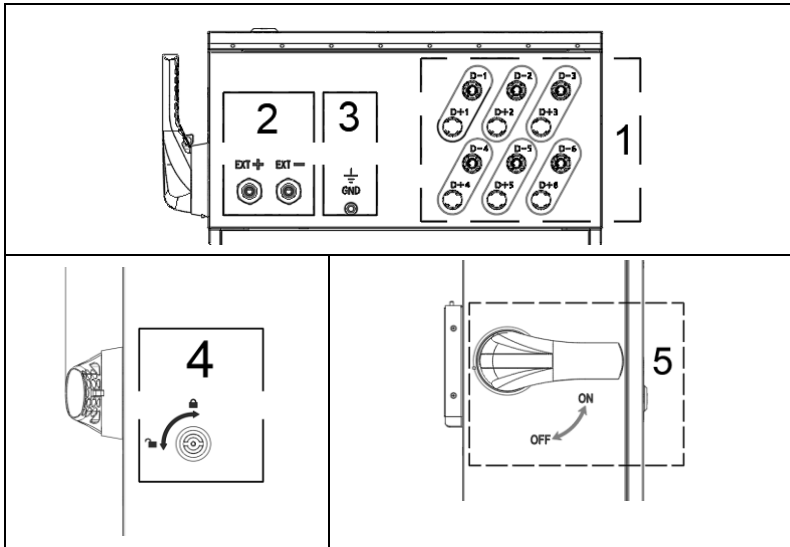

1) Power Terminal Input

Connect to Force-H-V2 battery power terminals.

*Make sure the battery type selected do support parallel operation features.

2) Power Terminal Output

Connect to inverter,

P-Combiner-HV-3, 6 AWG cable for maximum 50A current

P-Combiner-HV-6, 4AWG cable for maximum 100 A current

3) Grounding Point

For grounding cable, ensure after connection, the grounding resistance smaller than 0.1Ω

4) Door Lock

Using the lock provided together with box.

*Must lock correctly after installation.

5) Disconnect Switch

Switch ON/OFF of mains circuit.

2.2 Electrical Diagram

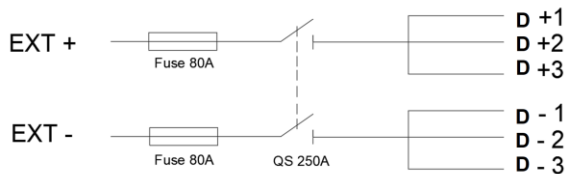

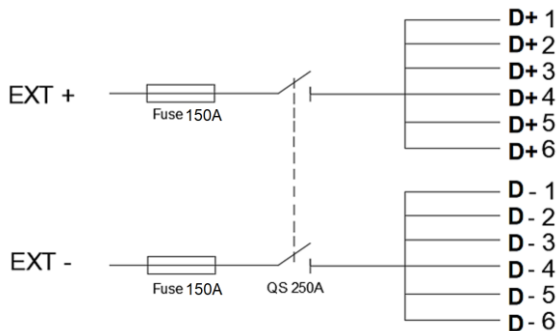

P-Combiner-HV-3



P-Combiner-HV-6

3. Safe handling of lithium batteries guide

3.1 Tools

 <p>Wire Cutter</p>	 <p>Socket Wrench M8 outer hexagon expansion bolt M6 hexagon bolt</p>	 <p>Screw Driver PH2</p>
---	---	--

3.2 Safety Gear

It is recommended to wear the following safety gear when dealing with the battery pack.



Insulated gloves



Safety goggles



Safety shoes





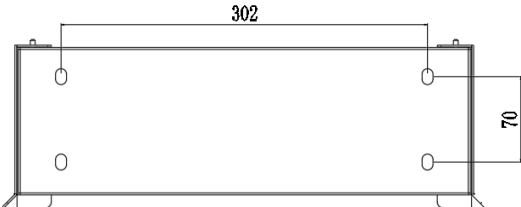

4. Installation and Operation

4.1 Package List

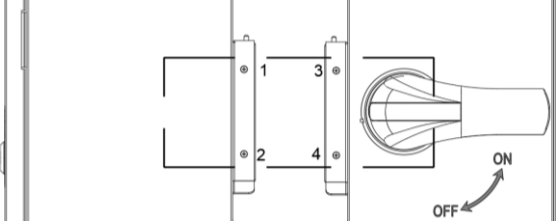
Item	Description	HV-3	HV-6
1	P-Combiner box (400*385*200, mm)	1	1
2	Power connector H4SFC8DM	3	6
3	Power connector H4SMC8DM	3	6
4	Expansion bolt (M8*60)	4	4
5	Power cable 4AWG*2m, SC25-8, orange	-	1
6	Power cable 4AWG*2m, SC25-8, black	-	1
7	Power cable 6AWG*2m, SC16-8, orange	1	-
8	Power cable 6AWG*2m, SC16-8, black	1	-
9	Grounding cable 10AWG*1m, yellow-green	1	1
10	Power terminal protection cover(set)	3	6
11	Wall mounting bracket (372.6*121*20, mm)	1	1
12	Fixing screws(M4*15)	4	4

4.2 Installation

<p>1. Positioning of expansion bolt: total 4 holes</p> <p>2. Install wall mounting bracket</p> <p>Torque: 12-13 N.m</p> <p>Tool: Socket Wrench</p> <p>Fastener: 4 pcs, M8*60 expansion bolt</p>	<p>Vertical:70mm</p> <p>Horizontal: 302mm</p> <p>Screw 4 holes for M8*60 expansion bolt and install the wall mounting bracket</p> 
<p>3. Hang on combiner box</p>	<p>Hanging the combiner box onto the wall mounting</p>

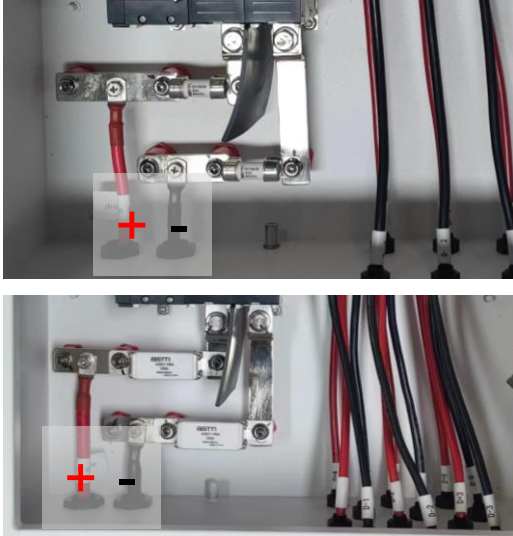
	bracket
<p>4.Fixing combiner box</p> <p>Torque: 1.5-2.5 N.m</p> <p>Tool: Screwdriver</p> <p>Fastener: 4pcs, M4*15</p>	 <p>Screw from right side of wall mounting bracket</p>
<p>5. Connect input power cables</p> <p> Ensure Disconnect Switch is OFF</p>	 <p>connect positive and negative cable from BMS to combiner box Power Input Terminal.</p> <p> Ensure NO reverse connection.</p> <p> Ensure all cables connect in pair: 1+ / 1- from same string of BMS.</p>
<p>6.Connect output power cable</p> <p> Ensure Disconnect Switch is OFF</p> <p>Torque: 4-5 N.m</p> <p>Tool: Socket Wrench</p> <p>Fastener: 2pcs, M6*10</p>	

	<p>connect positive and negative cable from inverter to combiner box Power Output Terminal.</p> <p> Ensure NO reverse connection.</p>
<p>7.Disconnect Switch ON/OFF</p>	<p>A) Switch on</p> <ol style="list-style-type: none">1)Double-check the wiring connection, ensure no reverse connection and wrong connection follow the electric diagram.2)Close and lock the door.3)Switch ON the Disconnect Switch, then further power on the BMSs and system follow the battery system operation manual. <p>B) Switch off</p> <ol style="list-style-type: none">1)For maintenance, please switch off all BMSs first then switch OFF the Disconnect Switch for safely operation.

4 Remarks

Recycle and disposal, follow local disposal rules.

Do NOT disposal directly.



PYLONTECH

Pylon Technologies Co., Ltd.

Stairs 5 No. 71, Lane 887, ZuChongzhi Road, Zhangjiang Hi-Tech Park Pudong
Shanghai 201203, China

T+86-21-51317699 | **F** +86-21-51317698

E service@pylontech.com.cn

W www.pylontech.com.cn